

## EPA Series

## 30 – 2700MHz RF Amplifier

### Features

- Frequency Range: 30-2700MHz
- Gain: 43dB
- P<sub>1dB</sub>: +25dBm
- OIP3: +35dBm
- Noise Figure: 4dB (typ.)
- DC Power: 12V @ 300mA
- SMA-female

### Photo



### Description

EPA-270T is a 43dB gain RF Amplifier, with frequency range of 30 MHz to 2700MHz.

### Electrical Specifications @+25 °C, Z<sub>in</sub>=Z<sub>out</sub>=50 Ω, V<sub>supply</sub> = +12VDC

Parameter	Unit	Minimum	Typical	Maximum
Frequency Range	MHz	30		2700
Gain (S21)	f = 30MHz		45.0	
	f = 1500MHz		47.0	
	f = 2700MHz		43.0	
Gain Flatness	dB		±3.0	
Output Power P <sub>1dB</sub>	dBm		+25	
Saturated Output Power P <sub>Sat</sub>	dBm		+27	
Output Third Order Intercept IP3	dBm		+35	
Noise Figure	dB		4.0	5.0
Reverse Isolation (S12)	dB		-55	
VSWR-Input (S11)	ratio:1	1.3@30MHz	1.4@1500MHz	1.5@2700MHz
VSWR-Output (S22)	(unitless)	1.8@30MHz	1.2@1500MHz	2.8@2700MHz
DC Power Supply - Voltage	V		12	
DC Power Supply - Current	mA		300	
Operating Temperature	°C	-40		+85
Size (RF/DC feedthrough excluded)	Inch	1.79 (L) x 1.10 (W) x 0.45 (H)		
Weight	Oz	1.4		

**EPA Series**

**30 – 2700MHz RF Amplifier**

**Typical Performance @+25 °C**

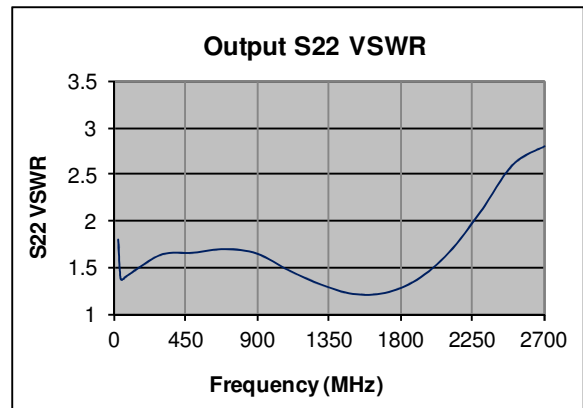
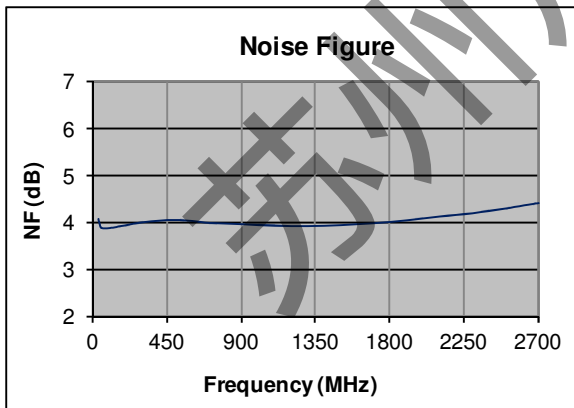
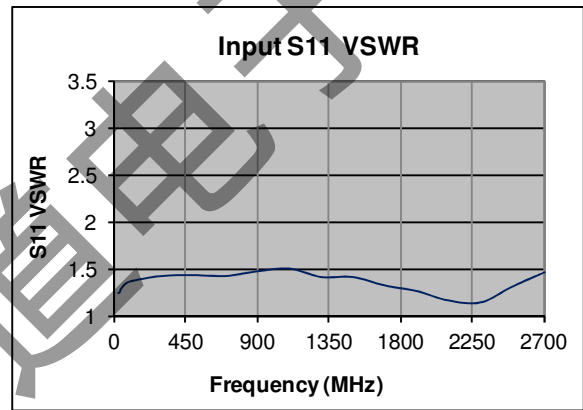
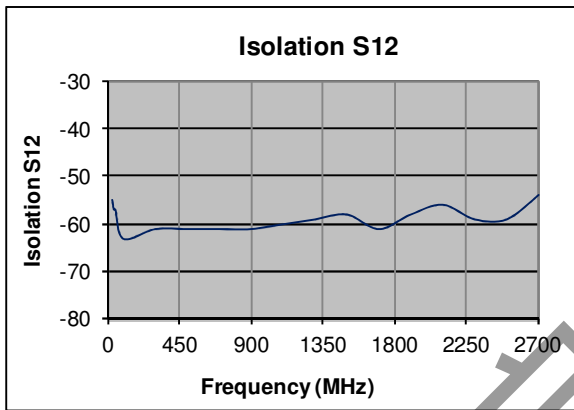
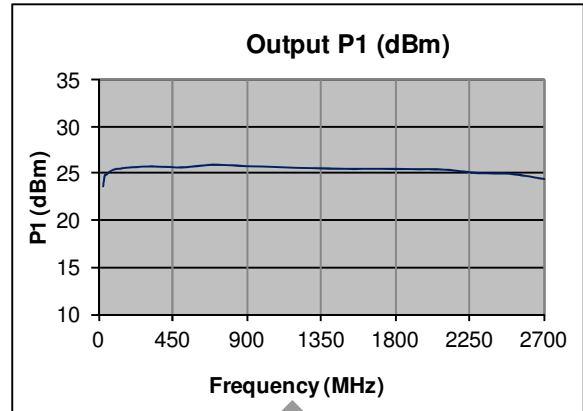
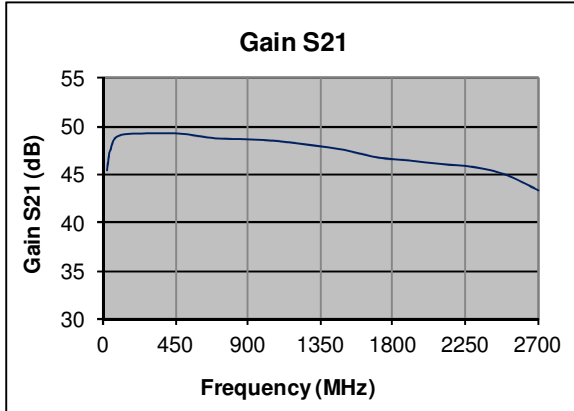

**EPA Series**

**30 – 2700MHz RF Amplifier**

**Typical Performance @+25 °C**

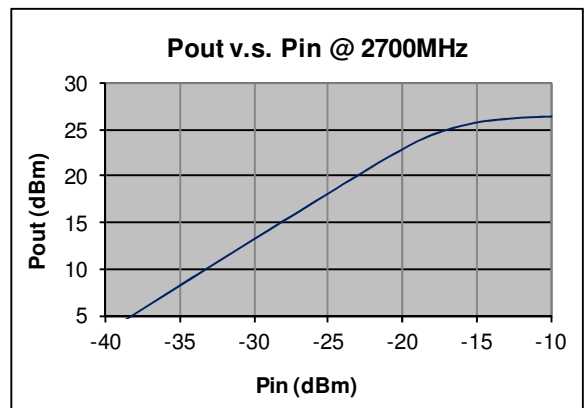
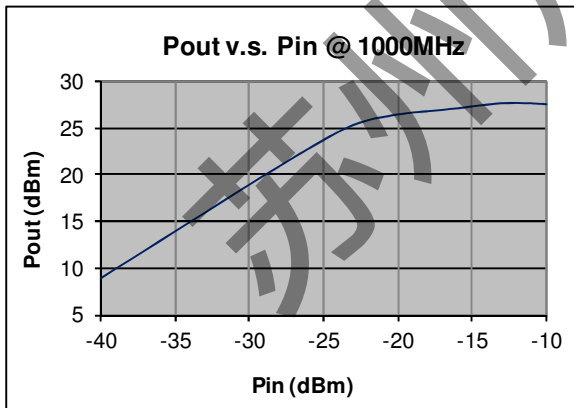
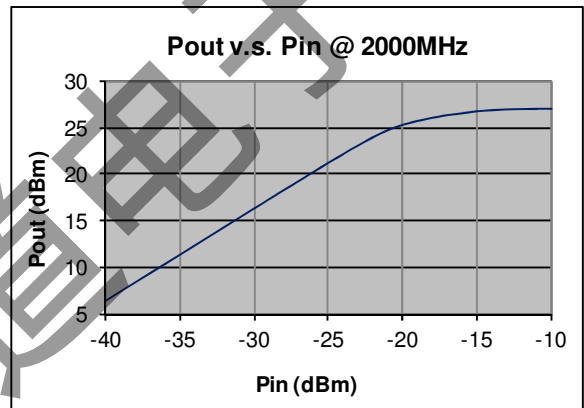
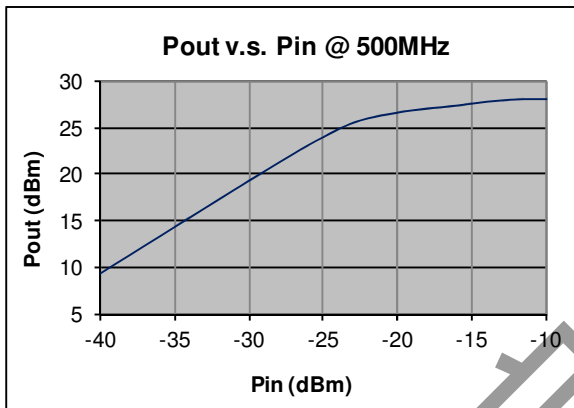
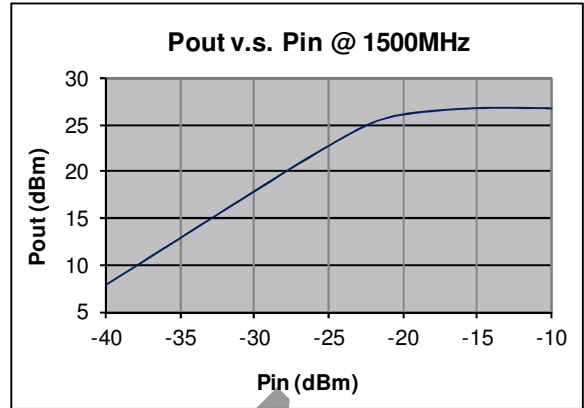
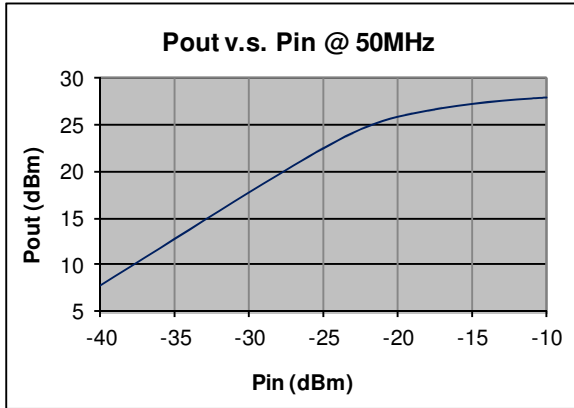

## EPA Series

## 30 – 2700MHz RF Amplifier

### Absolute Maximum Ratings

Parameter	Absolute Maximum
RF Input Power	+16dBm
Supply Voltage	+16V
Operating Temperature	-40 °C to +85 °C
Storage Temperature	-55 °C to +125 °C

### Outline

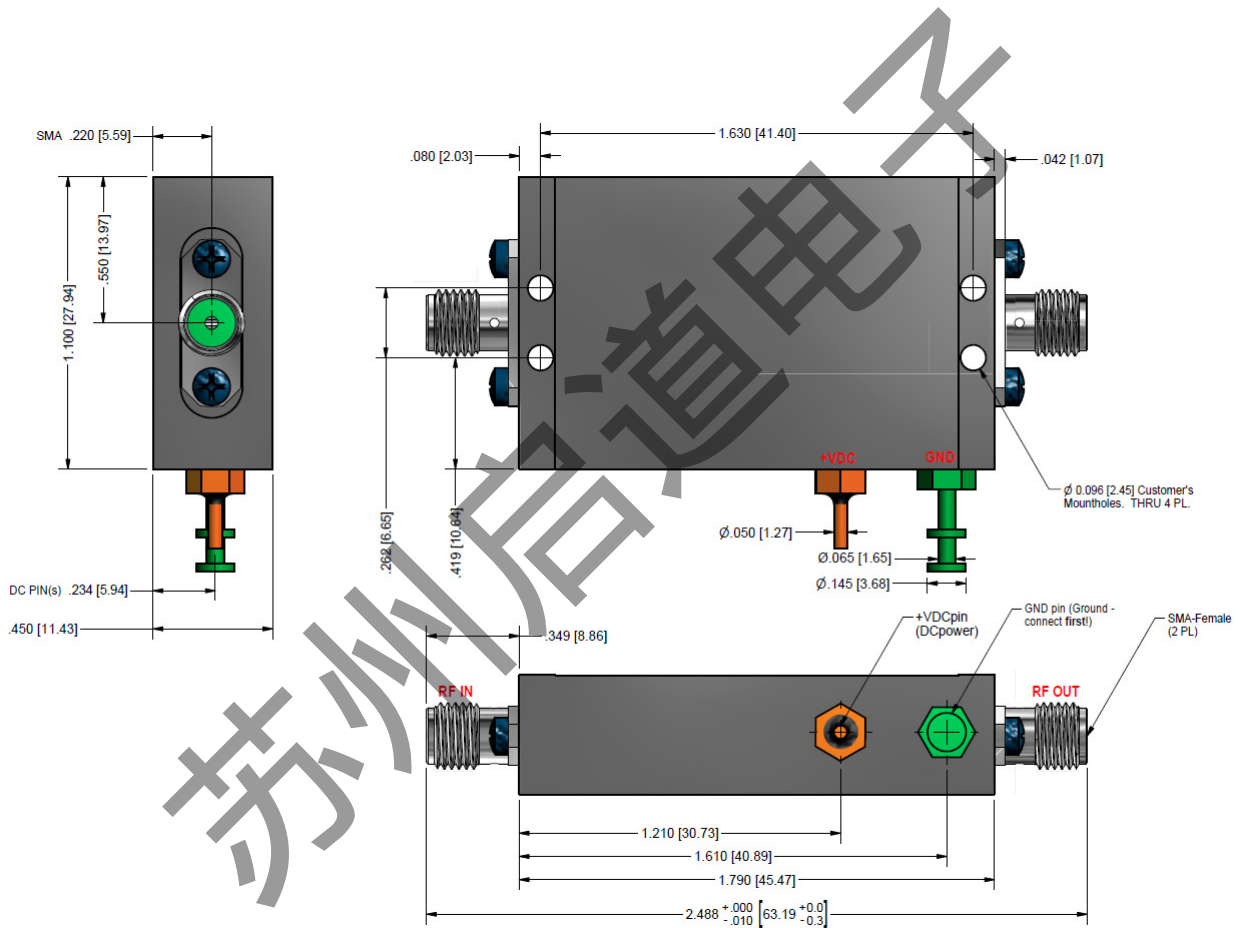

**WARNING: MUST USE HEAT SINK IF CASE TEMPERATURE EXCEEDS 50 °C**